

Nach DIN EN 10242 (vormals 2950).

Die Serie Tempergussfittings in Stahl schwarz, nicht verzinkt, ist die klassische Verschraubungsserie im Rohrleitungsbau. Unsere Tempergussfittings zeichnen sich durch hohe mechanische Beanspruchbarkeit und genormte Verbindungstechnologie aus.

Maximaler Einsatzbereich bei Minustemperaturen = -20 °C; 25 bar.

Zulässiger Betriebsdruck bei Temperaturen zwischen -20 °C und 120 °C = 25 bar.

Zulässiger Betriebsdruck bei Temperaturen zwischen 120 °C und 300 °C = 20-25 bar.

Material: schwarzer Temperguss B350-10 Design Symbol A
 Temperaturbereich: -20 °C bis +300 °C
 Oberfläche: schwarz
 Anschlussgewinde: nach ISO 7-1

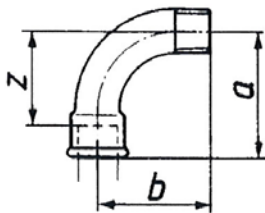

TFB 1-12-S

Bogen 1, lang, 90°, IG/AG, schwarz

Artikel Nr.	Ident Nr.	Gewinde innen	Gewinde außen	a mm	b mm	z mm
TFB 1-14-S	133572	Rp 1/4	R 1/4	40,0	36,0	30,0
TFB 1-38-S	133573	Rp 3/8	R 3/8	48,0	42,0	38,0
TFB 1-12-S	133574	Rp 1/2	R 1/2	55,0	48,0	42,0
TFB 1-34-S	133575	Rp 3/4	R 3/4	69,0	60,0	54,0
TFB 1-114-S	133576	Rp 1 1/4	R 1 1/4	105,0	95,0	86,0
TFB 1-112-S	133577	Rp 1 1/2	R 1 1/2	116,0	105,0	97,0
TFB 1-20-S	133578	Rp 2	R 2	140,0	130,0	116,0

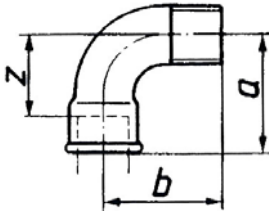

TFB 1-12-S

Bogen 1a, kurz, 90°, IG/AG, schwarz

Artikel Nr.	Ident Nr.	Gewinde innen	Gewinde außen	a mm	b mm	z mm
TFB 1A-38-S	133579	Rp 3/8	R 3/8	36,0	36,0	26,0
TFB 1A-12-S	133580	Rp 1/2	R 1/2	45,0	45,0	32,0
TFB 1A-34-S	133581	Rp 3/4	R 3/4	50,0	50,0	35,0
TFB 1A-10-S	133582	Rp 1	R 1	63,0	63,0	46,0
TFB 1A-114-S	133583	Rp 1 1/4	R 1 1/4	76,0	76,0	57,0
TFB 1A-112-S	133584	Rp 1 1/2	R 1 1/2	85,0	85,0	66,0
TFB 1A-20-S	133585	Rp 2	R 2	102,0	102,0	78,0
TFB 1A-212-S	133586	Rp 2 1/2	R 2 1/2	-	-	-

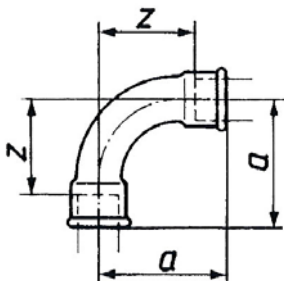

TFB 2-12-S

Bogen 2, lang, 90°, IG/IG, schwarz

Artikel Nr.	Ident Nr.	Gewinde innen	a mm	z mm
TFB 2-14-S	133587	Rp/Rp 1/4	40,0	30,0
TFB 2-38-S	133588	Rp/Rp 3/8	48,0	38,0
TFB 2-12-S	133589	Rp/Rp 1/2	55,0	42,0
TFB 2-34-S	133590	Rp/Rp 3/4	69,0	54,0
TFB 2-10-S	133591	Rp/Rp 1	85,0	68,0
TFB 2-114-S	133592	Rp/Rp 1 1/4	105,0	86,0
TFB 2-112-S	133593	Rp/Rp 1 1/2	116,0	97,0
TFB 2-20-S	133594	Rp/Rp 2	140,0	116,0
TFB 2-212-S	133595	Rp 2 1/2	176,0	149,0
TFB 2-30-S	133596	Rp 3	205,0	175,0

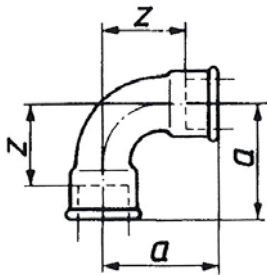

TFB 2A-12-S

Bogen 2a, kurz, 90°, IG/IG, schwarz

Artikel Nr.	Ident Nr.	Gewinde innen	a mm	z mm
TFB 2A-12-S	133597	Rp/Rp 1/2	45,0	32,0
TFB 2A-34-S	133598	Rp/Rp 3/4	50,0	35,0
TFB 2A-10-S	133599	Rp/Rp 1	63,0	46,0
TFB 2A-114-S	133600	Rp/Rp 1 1/4	76,0	57,0
TFB 2A-112-S	133601	Rp/Rp 1 1/2	85,0	66,0
TFB 2A-20-S	133602	Rp/Rp 2	102,0	78,0

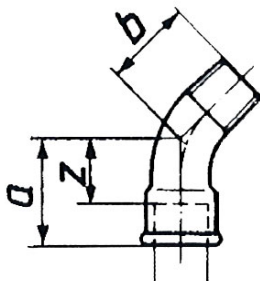

TFB 40-12-S

Bogen 40, 45°, IG/AG, schwarz

Artikel Nr.	Ident Nr.	Gewinde innen	Gewinde außen	a mm	b mm	z mm
TFB 40-14-S	133603	Rp 1/4	R 1/4	26,0	21,0	16,0
TFB 40-38-S	133604	Rp 3/8	R 3/8	30,0	24,0	20,0
TFB 40-12-S	133605	Rp 1/2	R 1/2	36,0	30,0	23,0
TFB 40-34-S	133606	Rp 3/4	R 3/4	43,0	36,0	28,0
TFB 40-10-S	133607	Rp 1	R 1	51,0	42,0	34,0
TFB 40-112-S	133608	Rp 1 1/2	R 1 1/2	68,0	58,0	49,0
TFB 40-20-S	133609	Rp 2	R 2	81,0	70,0	57,0
TFB 40-212-S	133610	Rp 2 1/2	R 2 1/2	99,0	86,0	72,0

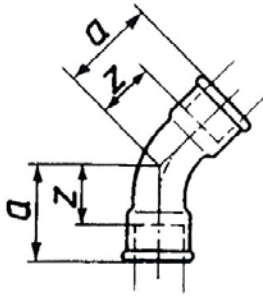

TFB 41-12-S

Bogen 41, 45°, IG/IG, schwarz

Artikel Nr.	Ident Nr.	Gewinde innen	a mm	z mm
TFB 41-38-S	133611	Rp/Rp 3/8	30,0	20,0
TFB 41-12-S	133612	Rp/Rp 1/2	36,0	23,0
TFB 41-34-S	133613	Rp/Rp 3/4	43,0	28,0
TFB 41-10-S	133614	Rp/Rp 1	51,0	34,0
TFB 41-114-S	133615	Rp/Rp 1 1/4	64,0	45,0
TFB 41-112-S	133616	Rp/Rp 1 1/2	68,0	49,0
TFB 41-20-S	133617	Rp/Rp 2	81,0	57,0
TFB 41-212-S	133618	Rp/Rp 2 1/2	99,0	72,0

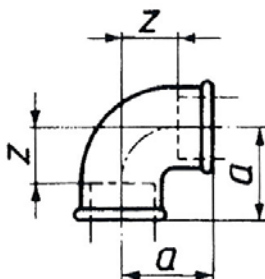

TFW 90-12-S

Winkel 90, 90°, IG/IG, schwarz

Artikel Nr.	Ident Nr.	Gewinde innen	a mm	z mm
TFW 90-14-S	133619	Rp/Rp 1/4	21,0	11,0
TFW 90-38-S	133620	Rp/Rp 3/8	25,0	15,0
TFW 90-12-S	133621	Rp/Rp 1/2	28,0	15,0
TFW 90-34-S	133622	Rp/Rp 3/4	33,0	18,0
TFW 90-10-S	133623	Rp/Rp 1	38,0	21,0
TFW 90-114-S	133624	Rp/Rp 1 1/4	45,0	26,0
TFW 90-112-S	133625	Rp/Rp 1 1/2	50,0	31,0
TFW 90-20-S	133626	Rp/Rp 2	58,0	34,0
TFW 90-212-S	133627	Rp/Rp 2 1/2	69,0	42,0
TFW 90-30-S	133628	Rp/Rp 3	78,0	48,0

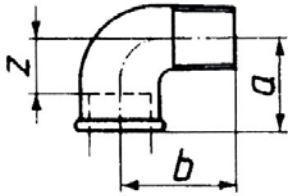

TFW 92-12-S

Winkel 92, IG/AG, 90°, schwarz

Artikel Nr.	Ident Nr.	Gewinde innen	Gewinde außen	a mm	b mm	z mm
TFW 92-14-S	133629	Rp 1/4	R 1/4	21,0	28,0	11,0
TFW 92-38-S	133630	Rp 3/8	R 3/8	25,0	32,0	15,0
TFW 92-12-S	133631	Rp 1/2	R 1/2	28,0	37,0	15,0
TFW 92-34-S	133632	Rp 3/4	R 3/4	33,0	43,0	18,0
TFW 92-10-S	133633	Rp 1	R 1	38,0	52,0	21,0
TFW 92-114-S	133634	Rp 1 1/4	R 1 1/4	45,0	60,0	26,0
TFW 92-112-S	133635	Rp 1 1/2	R 1 1/2	50,0	65,0	31,0
TFW 92-20-S	133636	Rp 2	R 2	58,0	74,0	34,0
TFW 92-212-S	133637	Rp 2 1/2	R 2 1/2	69,0	88,0	42,0

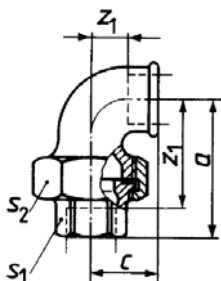

TFV 95-12-S

Verschraubung Bogen 95, flach dichtend, IG/IG, ohne Dichtung, schwarz

Artikel Nr.	Ident Nr.	Gewinde innen	a mm	b mm	c mm	z ₁ mm
TFV 95-12-S	133638	Rp 1/2	58,0	76,0	28,0	15,0
TFV 95-34-S	133639	Rp 3/4	62,0	82,0	33,0	18,0
TFV 95-10-S	133640	Rp 1	72,0	94,0	38,0	21,0
TFV 95-114-S	133641	Rp 1 1/4	82,0	107,0	45,0	26,0
TFV 95-112-S	133642	Rp 1 1/2	90,0	115,0	50,0	31,0
TFV 95-20-S	133643	Rp 2	100,0	128,0	58,0	34,0

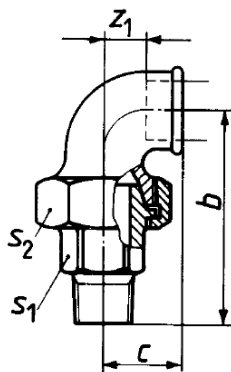

TFV 97-12-S

Verschraubung Bogen 97, flach dichtend, IG/AG, ohne Dichtung, schwarz

Artikel Nr.	Ident Nr.	Gewinde 1 außen	Gewinde 2 außen	b mm	c mm	z ₁ mm
TFV 97-12-S	133644	Rp 1/2	R 1/2	76,0	28,0	15,0
TFV 97-34-S	133645	Rp 3/4	R 3/4	82,0	33,0	18,0
TFV 97-10-S	133646	Rp 1	R 1	94,0	38,0	21,0
TFV 97-114-S	133647	Rp 1 1/4	R 1 1/4	45,0	45,0	26,06
TFV 97-112-S	133648	Rp 1 1/2	R 1 1/2	115,0	50,0	31,0
TFV 97-20-S	133649	Rp 2	R 2	128,0	58,0	34,0

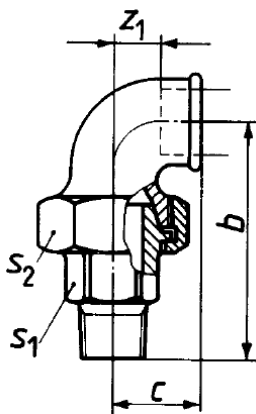

TFV 98-12-S

Verschraubung Bogen 98, konisch dichtend, IG/AG, schwarz

Artikel Nr.	Ident Nr.	Gewinde 1 außen	Gewinde 2 außen	b mm	c mm	z ₁ mm
TFV 98-12-S	133650	Rp 1/2	R 1/2	76,0	28,0	15,0
TFV 98-34-S	133651	Rp 3/4	R 3/4	82,0	33,0	18,0
TFV 98-10-S	133652	Rp 1	R 1	94,0	38,0	21,0
TFV 98-114-S	133653	Rp 1 1/4	R 1 1/4	107,0	45,0	26,0
TFV 98-20-S	133654	Rp 2	R 2	128,0	58,0	34,0

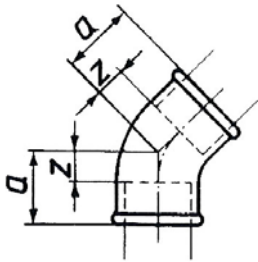

TFW 120-12-S

Winkel 120, 45°, IG/IG, schwarz

Artikel Nr.	Ident Nr.	Gewinde innen	a mm	z mm
TFW 120-38-S	133655	Rp/Rp /3/8	20,0	10,0
TFW 120-12-S	133656	Rp/Rp 1/2	22,0	9,0
TFW 120-34-S	133657	Rp/Rp 3/4	25,0	10,0
TFW 120-10-S	133658	Rp/Rp 1	28,0	11,0
TFW 120-114-S	133659	Rp/Rp 1 1/4	33,0	14,0
TFW 120-112-S	133660	Rp/Rp 1 1/2	36,0	17,0
TFW 120-20-S	133661	Rp/Rp 2	43,0	19,0
TFW 120-212-S	133662	Rp 2 1/2	-	-

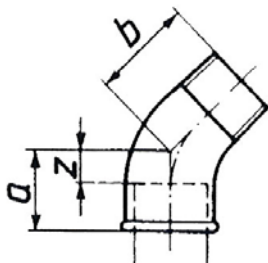

TFW 121-12-S

Winkel 121, 45°, IG/AG, schwarz

Artikel Nr.	Ident Nr.	Gewinde innen	Gewinde außen	a mm	b mm	z mm
TFW 121-38-S	133663	Rp 3/8	R 3/8	20,0	25,0	10,0
TFW 121-12-S	133664	Rp 1/2	R 1/2	22,0	28,0	9,0
TFW 121-34-S	133665	Rp 3/4	R 3/4	25,0	32,0	10,0
TFW 121-10-S	133666	Rp 1	R 1	28,0	37,0	11,0
TFW 121-114-S	133667	Rp 1 1/4	R 1 1/4	33,0	43,0	14,0
TFW 121-112-S	133668	Rp 1 1/2	R 1 1/2	36,0	46,0	17,0
TFW 121-20-S	133669	Rp 2	R 2	43,0	55,0	19,0

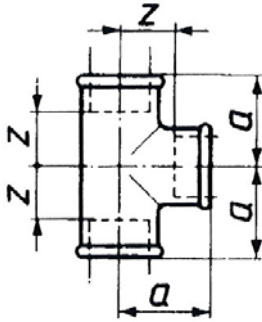

TFT 130-12-S

T-Stück 130, IG/IG/IG, schwarz

Artikel Nr.	Ident Nr.	Gewinde innen	a mm	z mm
TFT 130-14-S	133670	Rp 1/4	21,0	11,0
TFT 130-38-S	133671	Rp 3/8	25,0	15,0
TFT 130-12-S	133672	Rp 1/2	28,0	15,0
TFT 130-34-S	133673	Rp 3/4	33,0	18,0
TFT 130-10-S	133674	Rp 1	38,0	21,0
TFT 130-114-S	133675	Rp 1 1/4	45,0	26,0
TFT 130-112-S	133676	Rp 1 1/2	50,0	31,0
TFT 130-20-S	133677	Rp 2	58,0	34,0

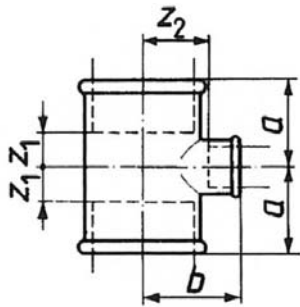

TFT 130-1238-S

T-Stück 130, reduzierend, IG/IG/IG, schwarz

Artikel Nr.	Ident Nr.	Gewinde 1	Gewinde 2 T-Abzweig reduziert	a mm	b mm	z ₁ mm	z ₂ mm
TFT 130-1238-S	133678	Rp/Rp 1/2	Rp 3/8	26,0	26,0	13,0	16,0
TFT 130-3412-S	133679	Rp/Rp 3/4	Rp 1/2	30,0	31,0	15,0	18,0
TFT 130-1012-S	133680	Rp/Rp 1	Rp 1/2	32,0	34,0	15,0	21,0
TFT 130-1034-S	133681	Rp/Rp 1	Rp 3/4	35,0	36,0	18,0	21,0
TFT 130-11412-S	133682	Rp/Rp 1 1/4	Rp 1/2	34,0	38,0	15,0	25,0
TFT 130-11434-S	133683	Rp/Rp 1 1/4	Rp 3/4	36,0	41,0	17,0	26,0
TFT 130-11410-S	133684	Rp/Rp 1 1/4	Rp 1	40,0	42,0	21,0	25,0
TFT 130-11212-S	133685	Rp/Rp 1 1/2	Rp 1/2	36,0	42,0	17,0	29,0
TFT 130-11234-S	133686	Rp/Rp 1 1/2	Rp 3/4	38,0	44,0	19,0	29,0
TFT 130-11210-S	133687	Rp/Rp 1 1/2	Rp 1	42,0	46,0	23,0	29,0
TFT 130-2012-S	133689	Rp/Rp 2	Rp 1/2	38,0	48,0	14,0	35,0
TFT 130-2034-S	133690	Rp/Rp 2	Rp 3/4	40,0	50,0	16,0	35,0
TFT 130-2010-S	133691	Rp/Rp 2	Rp 1	44,0	52,0	20,0	35,0
TFT 130-20112-S	133692	Rp/Rp 2	Rp 1 1/2	52,0	55,0	28,0	36,0

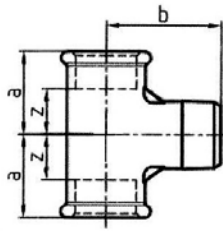

TFT 133-12-S

T-Stück 133, IG/AG/IG, schwarz

Artikel Nr.	Ident Nr.	Gewinde	a mm	b mm	z mm
TFT 133-38-S	133693	Rp 3/8	22	31	12
TFT 133-12-S	133694	Rp 1/2	25	38	12
TFT 133-10-S	133695	Rp 1	39	53	22

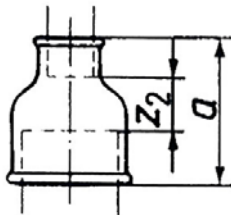

TFM 240-1012-S

Muffe 240, reduzierend, IG/IG, schwarz

Artikel Nr.	Ident Nr.	Gewinde 1 innen	Gewinde 2 innen	a mm	z ₂ mm
TFM 240-3814-S	133696	Rp 3/8	Rp 1/4	30,0	10,0
TFM 240-1214-S	133697	Rp 1/2	Rp 1/4	36,0	13,0
TFM 240-1238-S	133698	Rp 1/2	Rp 3/8	36,0	13,0
TFM 240-3438-S	133699	Rp 3/4	Rp 3/8	39,0	14,0
TFM 240-3412-S	133700	Rp 3/4	Rp 1/2	38,0	11,0
TFM 240-1038-S	133701	Rp 1	Rp 3/8	45,0	18,0
TFM 240-1012-S	133702	Rp 1	Rp 1/2	45,0	15,0
TFM 240-1034-S	133703	Rp 1	Rp 3/4	45,0	13,0
TFM 240-11412-S	133704	Rp 1 1/4	Rp 1/2	50,0	18,0
TFM 240-11434-S	133705	Rp 1 1/4	Rp 3/4	50,0	16,0
TFM 240-11410-S	133706	Rp 1 1/4	Rp 1	50,0	14,0
TFM 240-11212-S	133707	Rp 1 1/2	Rp 1/2	55,0	23,0
TFM 240-11234-S	133708	Rp 1 1/2	Rp 3/4	55,0	21,0
TFM 240-11210-S	133709	Rp 1 1/2	Rp 1	55,0	19,0
TFM 240-2012-S	133710	Rp 2	Rp 1/2	65,0	28,0
TFM 240-2034-S	133711	Rp 2	Rp 3/4	65,0	26,0
TFM 240-2010-S	133712	Rp 2	Rp 1	65,0	24,0
TFM 240-20114-S	133713	Rp 2	Rp 1 1/4	65,0	22,0
TFM 240-20112-S	133714	Rp 2	Rp 1 1/2	65,0	22,0
TFM 240-21220-S	133715	Rp 2 1/2	Rp 2	74,0	23,0
TFM 240-3020-S	133716	Rp 3	Rp 2	80,0	26,0

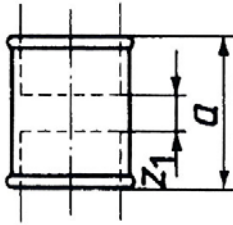

TFM 270-12-S

Muffe 270, IG/IG, schwarz

Artikel Nr.	Ident Nr.	Gewinde innen	a mm	z ₁ mm
TFM 270-14-S	133717	Rp/Rp 1/4	27,0	7,0
TFM 270-38-S	133718	Rp/Rp 3/8	30,0	10,0
TFM 270-12-S	133719	Rp/Rp 1/2	36,0	10,0
TFM 270-34-S	133720	Rp/Rp 3/4	39,0	9,0
TFM 270-10-S	133721	Rp/Rp 1	45,0	11,0
TFM 270-114-S	133722	Rp/Rp 1 1/4	50,0	12,0
TFM 270-112-S	133723	Rp/Rp 1 1/2	50,0	17,0
TFM 270-20-S	133724	Rp/Rp 2	65,0	17,0
TFM 270-212-S	133725	Rp 2 1/2	74,0	20,0
TFM 270-30-S	133726	Rp 3	80,0	20,0

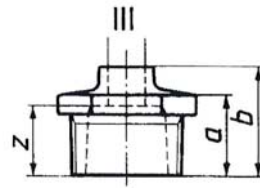
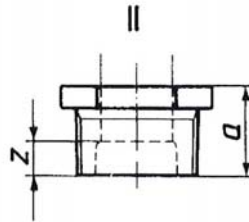
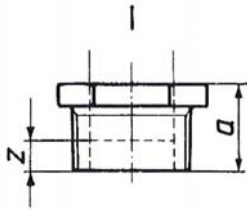

TFR 241-1012-S

Reduzierstück 241, AG/IG, schwarz

Artikel Nr.	Ident Nr.	Gewinde 1 außen	Gewinde 2 innen	a mm	b mm	z mm	Form
TFR 241-3814-S	133727	R 3/8	Rp 1/4	20,0	-	10,0	I
TFR 241-1214-S	133728	R 1/2	Rp 1/4	24,0	-	14,0	II
TFR 241-1238-S	133729	R 1/2	Rp 3/8	24,0	-	14,0	I
TFR 241-3414-S	133730	R 3/4	Rp 1/4	26,0	-	16,0	II
TFR 241-3438-S	133731	R 3/4	Rp 3/8	26,0	-	16,0	II
TFR 241-3412-S	133732	R 3/4	Rp 1/2	26,0	-	13,0	I
TFR 241-1038-S	133733	R 1	Rp 3/8	29,0	-	19,0	II
TFR 241-1012-S	133734	R 1	Rp 1/2	29,0	-	16,0	II
TFR 241-1034-S	133735	R 1	Rp 3/4	29,0	-	14,0	I
TFR 241-11412-S	133736	R 1 1/4	Rp 1/2	31,0	-	18,0	II
TFR 241-11434-S	133737	R 1 1/4	Rp 3/4	31,0	-	16,0	II
TFR 241-11410-S	133738	R 1 1/4	Rp 1	31,0	-	14,0	I
TFR 241-11212-S	133739	R 1 1/2	Rp 1/2	31,0	-	18,0	II
TFR 241-11234-S	133740	R 1 1/2	Rp 3/4	31,0	-	16,0	II
TFR 241-11210-S	133741	R 1 1/2	Rp 1	31,0	-	14,0	II
TFR 241-2012-S	133742	R 2	Rp 1/2	35,0	48,0	35,0	III
TFR 241-2034-S	133743	R 2	Rp 3/4	35,0	48,0	33,0	III
TFR 241-2010-S	133744	R 2	Rp 1	35,0	-	18,0	II
TFR 241-20114-S	133745	R 2	Rp 1 1/4	35,0	-	16,0	II
TFR 241-20112-S	133746	R 2	Rp 1 1/2	35,0	-	16,0	II
TFR 241-21220-S	133747	R 2 1/2	Rp 2	40,0	-	16,0	II
TFR 241-30112-S	133748	R 3	Rp 1 1/2	44,0	59,0	40,0	III

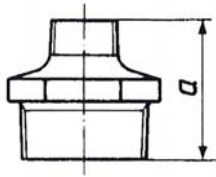

TFD 245-1214-S

Doppelnippel 245, reduzierend, AG/AG, schwarz

Artikel Nr.	Ident Nr.	Gewinde 1 außen	Gewinde 2 außen	a mm
TFD 245-3814-S	133749	R 3/8	R 1/4	38,0
TFD 245-1214-S	133750	R 1/2	R 1/4	44,0
TFD 245-1238-S	133751	R 1/2	R 3/8	44,0
TFD 245-3438-S	133752	R 3/4	R 3/8	47,0
TFD 245-3412-S	133753	R 3/4	R 1/2	47,0
TFD 245-1012-S	133754	R 1	R 1/2	53,0
TFD 245-1034-S	133755	R 1	R 3/4	53,0
TFD 245-11434-S	133756	R 1 1/4	R 3/4	57,0
TFD 245-11410-S	133757	R 1 1/4	R 1	57,0
TFD 245-11210-S	133758	R 1 1/2	R 1	59,0
TFD245-112114-S	133759	R 1 1/2	R 1 1/4	59,0
TFD 245-20114-S	133760	R 2	R 1 1/4	68,0
TFD 245-20112-S	133761	R 2	R 1 1/2	68,0
TFD245-212112-S	133762	R 2 1/2	R 1 1/2	75,0
TFD 245-21220-S	133763	R 2 1/2	R 2	75,0

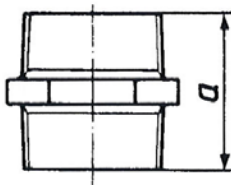

TFD 280-12-S

Doppelnippel 280, AG/AG, schwarz

Artikel Nr.	Ident Nr.	Gewinde außen	a mm
TFD 280-14-S	133764	R 1/4	36,0
TFD 280-38-S	133765	R 3/8	38,0
TFD 280-12-S	133766	R 1/2	44,0
TFD 280-34-S	133767	R 3/4	47,0
TFD 280-10-S	133768	R 1	53,0
TFD 280-114-S	133769	R 1 1/4	57,0
TFD 280-112-S	133770	R 1 1/2	59,0
TFD 280-20-S	133771	R 2	68,0
TFD 280-212-S	133772	R 2 1/2	-

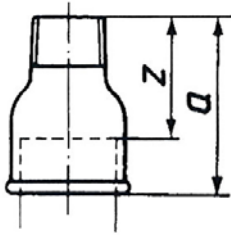

TFM 246-1012-S

Reduziermuffe 246, IG/AG, schwarz

Artikel Nr.	Ident Nr.	Gewinde 1 innen	Gewinde 2 außen	a mm	z mm
TFM 246-3814-S	133773	Rp 3/8	R 1/4	35,0	25,0
TFM 246-1214-S	133774	Rp 1/2	R 1/4	43,0	30,0
TFM 246-1238-S	133775	Rp 1/2	R 3/8	43,0	30,0
TFM 246-3412-S	133776	Rp 3/4	R 1/2	48,0	33,0
TFM 246-1012-S	133777	Rp 1	R 1/2	55,0	38,0
TFM 246-1034-S	133778	Rp 1	R 3/4	55,0	38,0
TFM 246-11434-S	133779	Rp 1 1/4	R 3/4	60,0	41,0
TFM 246-11410-S	133780	Rp 1 1/4	R 1	60,0	41,0
TFM 246-11234-S	133786	Rp 1 1/2	R 3/4	-	-
TFM 246-11210-S	133781	Rp 1 1/2	R 1	63,0	44,0
TFM 246-2010-S	133782	Rp 2	R 1	65,0	43,0
TFM 246-20114-S	133783	Rp 2	R 1 1/4	70,0	46,0
TFM 246-20112-S	133784	Rp 2	R 1 1/2	70,0	46,0
TFM 246-21220-S	133785	Rp 2 1/2	R 2	-	-

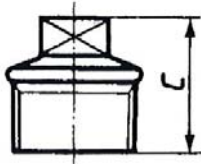

TFS 290-12-S

Stopfen 290, AG, schwarz

Artikel Nr.	Ident Nr.	Gewinde außen	c min. mm
TFS 290-14-S	133787	R 1/4	22,0
TFS 290-38-S	133788	R 3/8	24,0
TFS 290-12-S	133789	R 1/2	26,0
TFS 290-34-S	133790	R 3/4	32,0
TFS 290-10-S	133791	R 1	36,0
TFS 290-114-S	133792	R 1 1/4	39,0
TFS 290-112-S	133793	R 1 1/2	41,0
TFS 290-20-S	133794	R 2	48,0
TFS 290-212-S	133795	R 2 1/2	54,0
TFS 290-30-S	133796	R 3	60,0



TFK 300-12-S

Kappe 300, IG, schwarz

Artikel Nr.	Ident Nr.	Gewinde innen	a min. mm
TFK 300-14-S	133797	Rp 1/4	15,0
TFK 300-38-S	133798	Rp 3/8	17,0
TFK 300-12-S	133799	Rp 1/2	19,0
TFK 300-34-S	133800	Rp 3/4	22,0
TFK 300-10-S	133801	Rp 1	24,0
TFK 300-114-S	133802	Rp 1 1/4	27,0
TFK 300-112-S	133803	Rp 1 1/2	27,0
TFK 300-20-S	133804	Rp 2	32,0
TFK 300-212-S	133805	Rp 2 1/2	35,0

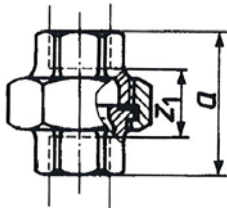

TFV 330-12-DS

Verschraubung 330, flach dichtend, IG/IG, mit NBR-Dichtung (NBR mit Aramidfasern), schwarz

Artikel Nr.	Ident Nr.	Gewinde innen	a mm	Z ₁ mm
TFV 330-38-DS	133806	Rp/Rp 3/8	45,0	25,0
TFV 330-12-DS	133807	Rp/Rp 1/2	48,0	22,0
TFV 330-34-DS	133808	Rp/Rp 3/4	52,0	22,0
TFV 330-10-DS	133809	Rp/Rp 1	58,0	24,0
TFV 330-114-DS	133810	Rp/Rp 1 1/4	65,0	27,0
TFV 330-112-DS	133811	Rp/Rp 1 1/2	70,0	32,0
TFV 330-20-DS	133812	Rp/Rp 2	78,0	30,0
TFV 330-212-DS	133813	Rp/Rp 2 1/2	85,0	31,0
TFV 330-30-DS	133814	Rp/Rp 3	95,0	35,0

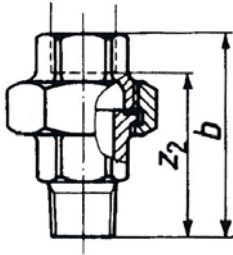

TFV 331-12-DS

Verschraubung 331, flach dichtend, IG/AG, mit NBR-Dichtung (NBR mit Aramidfasern), schwarz

Artikel Nr.	Ident Nr.	Gewinde innen	Gewinde außen	b mm	z ₂ mm
TFV 331-12-DS	133815	Rp 1/2	R 1/2	66,0	53,0
TFV 331-34-DS	133816	Rp 3/4	R 3/4	72,0	57,0
TFV 331-10-DS	133817	Rp 1	R 1	80,0	63,0
TFV 331-114-DS	133818	Rp 1 1/4	R 1 1/4	90,0	71,0
TFV 331-112-DS	133819	Rp 1 1/2	R 1 1/2	95,0	76,0
TFV 331-20-DS	133820	Rp 2	R 2	106,0	82,0
TFV 331-212-DS	133821	Rp 2 1/2	R 2 1/2	118,0	91,0

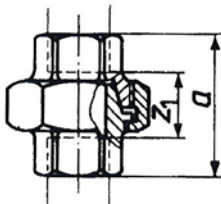

TFV 340-12-S

Verschraubung 340, konisch dichtend, IG/IG, schwarz

Artikel Nr.	Ident Nr.	Gewinde innen	a mm	z ₁ mm
TFV 340-38-S	133822	Rp/Rp 3/8	45,0	25,0
TFV 340-12-S	133823	Rp/Rp 1/2	48,0	22,0
TFV 340-34-S	133824	Rp/Rp 3/4	52,0	22,0
TFV 340-10-S	133825	Rp/Rp 1	58,0	24,0
TFV 340-114-S	133826	Rp/Rp 1 1/4	65,0	27,0
TFV 340-112-S	133827	Rp/Rp 1 1/2	70,0	32,0
TFV 340-212-S	133828	Rp/Rp 2 1/2	85,0	31,0

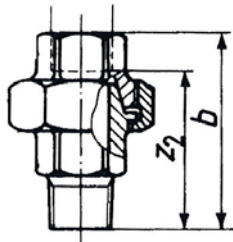

TFV 341-12-S

Verschraubung 341, konisch dichtend, IG/AG, schwarz

Artikel Nr.	Ident Nr.	Gewinde innen	Gewinde außen	b mm	z ₂ mm
TFV 341-38-S	133829	Rp 3/8	R 3/8	58,0	48,0
TFV 341-12-S	133830	Rp 1/2	R 1/2	66,0	53,0
TFV 341-34-S	133831	Rp 3/4	R 3/4	72,0	57,0
TFV 341-10-S	133832	Rp 1	R 1	80,0	63,0
TFV 341-114-S	133833	Rp 1 1/4	R 1 1/4	90,0	71,0
TFV 341-112-S	133834	Rp 1 1/2	R 1 1/2	95,0	76,0
TFV 341-20-S	133835	Rp 2	R 2	106,0	82,0
TFV 341-212-S	133836	Rp 2 1/2	Rp 2 1/2	118,0	91,0
TFV 341-30-S	133837	Rp 3	Rp 3	130,0	100,0

Flachdichtungen, ASTM F 36 J (NBR mit Aramidfasern)

Artikel Nr.	Ident Nr.	Gewinde	Außen-Ø mm	Innen-Ø mm	Stärke mm
TFD 14	113199	1/4	24,0	17,0	2,0
TFD 38	113200	3/8	27,0	19,0	2,0
TFD 12	113201	1/2	30,0	21,0	2,0
TFD 34	113202	3/4	38,0	27,0	2,0
TFD 10	113203	1	44,0	32,0	2,0
TFD 114	113204	1 1/4	55,0	42,0	2,0
TFD 112	113205	1 1/2	62,0	46,0	2,0
TFD 20	113206	2	78,0	60,0	2,0
TFD 212	113207	2 1/2	97,0	75,0	2,0
TFD 30	113208	3	110,0	88,0	2,0



TFD 12

Bei den angegebenen Abmessungen handelt es sich um Circa-Maße in mm.

Die Maße der Schlüsselweiten bleiben laut Vorgabe DIN EN 10242 dem Hersteller überlassen und können daher variieren.