

Serie »MI und MSI«

11.DM.08010–11.DM.40600, 11.EM.08010–11.EM.40150

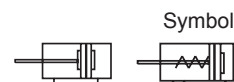

Produktbeschreibung

Rundzylinder aus Edelstahl in verschiedenen Ausführungen:

- doppelwirkend
- einfachwirkend

Doppelwirkend, Ø 8–25, nach ISO 6432, Bodendeckel mit Gewindezapfen - Schwenkausführung, Typ »CA«

Doppelwirkend, Ø 32–40, Bodendeckel mit Gewindezapfen rund - Schwenkausführung, Typ »CM«

Einfachwirkend, Ø 8–25, Bodendeckel mit Gewindezapfen - Schwenkausführung, Typ »CA«

Einfachwirkend, Ø 32–40, Bodendeckel mit Gewindezapfen rund - Schwenkausführung, Typ »CM«

Technische Daten

Kolben-Ø [mm]	8	10	12	16	20	25	32	40
Wirkprinzip	Doppelwirkend / einfachwirkend - in Grundstellung eingefahren							
Medium	Gefilterte und ungeölte oder geölte Druckluft. (Filtration mit 40 µm Filter notwendig). Bei Verwendung von geölter Druckluft auf kontinuierliche Ölung achten.							
Arbeitsdruck	doppelwirkend	1–10 bar (0,1 bis 1,0 MPa; 14 bis 145 psi)						
	einfachwirkend	2–10 bar (0,2 bis 1,0 MPa; 28 bis 145 psi)						
Prüfdruck	15 bar (1,5 MPa; 215 psi)							
Temperaturbereich	-20 bis 70 °C							
Geschwindigkeitsbereich	Doppelwirkend: 30–800 mm/s; einfachwirkend: 50–800 mm/s							
Dämpfungstyp	Nicht einstellbar / Dämpfungsring							
Anschlussgröße	M5x0,8				1/8"		1/4"	

Kolbenhub

Kolben-Ø [mm]		Standardhub		Max. Kolbenhub	Verfügbare Kolbenhub
doppelwirkend	8	10 / 15 / 20 / 25 / 30 / 40 / 50 / 60 / 75 / 80 / 100 / 125 / 150		150	200
	10	10 / 15 / 20 / 25 / 30 / 40 / 50 / 60 / 75 / 80 / 100 / 125 / 150 / 160 / 175 / 200		200	200
	12	10 / 15 / 20 / 25 / 30 / 40 / 50 / 60 / 75 / 80 / 100 / 125 / 150 / 160 / 175 / 200 / 250		250	500
	16	10 / 15 / 20 / 25 / 30 / 40 / 50 / 60 / 75 / 80 / 100 / 125 / 150 / 160 / 175 / 200 / 250 / 300		300	500
	20			500	700
	25	10 / 15 / 20 / 25 / 30 / 40 / 50 / 60 / 75 / 80 / 100 / 125 / 150 / 160 / 175 / 200 / 250 /		600	700
	32	300 / 350 / 400 / 450 / 500 / 600		600	700
	40			600	700
einfachwirkend	8			-	-
	10	10 / 15 / 20 / 25 / 30 / 40 / 50		-	-
	12			-	-
	16	10 / 15 / 20 / 25 / 30 / 40 / 50 / 60 / 75 / 80 / 100		-	-
	20			-	-
	25	10 / 15 / 20 / 25 / 30 / 40 / 50 / 60 / 75 / 80 / 100 / 125 / 150		-	-
	32			-	-
	40			-	-

(Werte in mm)

Hinweis: Weitere Hub-Ausführungen auf Anfrage.

Serie »MI und MSI«

11.DM.08010–11.DM.40600, 11.EM.08010–11.EM.40150

Bestellinformationen »MI«, doppeltwirkend

Artikel Nr.	Kolben-Ø	Hub	Anschluss	Kolbenstangenaußengewinde
11.DM.08010–08150	8	10–150	M5x0,8	M4x0,7
11.DM.10010–10200	10	10–200	M5x0,8	M4x0,7
11.DM.12010–12250	12	10–250	M5x0,8	M6x1,0
11.DM.16010–16300	16	10–300	M5x0,8	M6x1,0
11.DM.20010–20600	20	10–600	G 1/8	M8x1,25
11.DM.25010–25600	25	10–600	G 1/8	M10x1,25
11.DM.32010–32600	32	10–600	G 1/8	M10x1,25
11.DM.40010–40600	40	10–600	G 1/4	M12x1,25

(Werte in mm)

Bestellinformationen »MSI«, einfachwirkend

Artikel Nr.	Kolben-Ø	Hub	Anschluss	Kolbenstangenaußengewinde
11.EM.08010–08050	8	10–50	M5x0,8	M4x0,7
11.EM.10010–10050	10	10–50	M5x0,8	M4x0,7
11.EM.12010–12050	12	10–50	M5x0,8	M6x1,0
11.EM.16010–16100	16	10–100	M5x0,8	M6x1,0
11.EM.20010–20150	20	10–150	G 1/8	M8x1,25
11.EM.25010–25150	25	10–150	G 1/8	M10x1,25
11.EM.32010–32150	32	10–150	G 1/8	M10x1,25
11.EM.40010–40150	40	10–150	G 1/4	M12x1,25

(Werte in mm)

Serie »MI und MSI«

11.DM.08010–11.DM.40600, 11.EM.08010–11.EM.40150

Maße »MI«, doppelwirkend

Ø 8–25

Typ CA

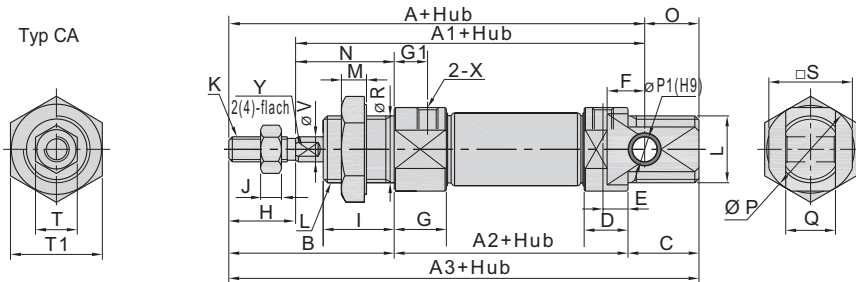

Ø 32–40

Typ CM

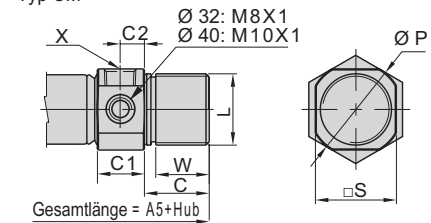

Auf Anfrage:

Typ R

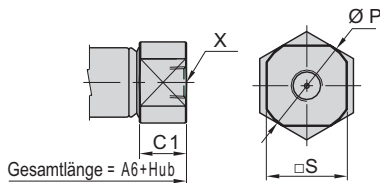

Typ U

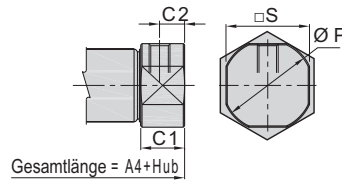

Kolben-Ø	A	A1	A2	A3	A4	A5	A6	B	C	C1	C2	D	E	F	G	G1	H	I
8	76	64	46	86	74	-	-	28	12	9,5	5	9,5	5	6	11,5	7	12	12
10	76	64	46	86	74	-	-	28	12	9,5	5	9,5	5	6	11,5	7	12	12
12	91	75	50	105	88	-	-	38	17	10,5	6	10,5	6	9	12,5	8	16	17
16	98	82	56	111	94	111	94	38	17	10,5	6	10,5	6	9	12,5	8	16	17
20	115	95	62	126	106	126	106	44	20	14,5	7,5	14,5	7,5	12	14,5	7,5	20	20
25	126	104	65	137	114,5	137	115	50	22	16	8	16	8	12	16	8	22	22
32	-	-	-	-	125	140	126	58	14	16,5	9	-	-	-	16,5	9	20	30
40	-	-	-	-	158	174	158	69	16	22	12	-	-	-	22	12	24	35

Kolben-Ø	J	K	L	M	N	O	P	P1	Q	R	S	T	T1	X	V	W	Y
8	2,5	M4x0,7	M12x1,25	6	16	10	17	4	8	12	15	7	17	M5x0,8	4	-	-
10	2,5	M4x0,7	M12x1,25	6	16	10	17	4	8	12	15	7	17	M5x0,8	4	-	-
12	5	M6x1,0	M16x1,5	6	22	14	20	6	12	16	18	10	22	M5x0,8	6	-	5
16	5	M6x1,0	M16x1,5	6	22	13	22	6	12	16	20	10	22	M5x0,8	6	13,5	5
20	6	M8x1,25	M22x1,5	7	24	11	29	8	16	22	25	12	29	1/8 ⁽¹⁾	8	16,5	6
25	6	M10x1,25	M22x1,5	7	28	11	33,5	8	16	22	30	17	29	1/8 ⁽¹⁾	10	18,5	8
32	6	M10x1,25	M30x1,5	7	38	-	37,5	-	-	30	34,5	17	36	1/8 ⁽¹⁾	12	10,5	10
40	7	M12x1,25	M38x1,5	8	45	-	46,5	-	-	38	42,5	17	46	1/4 ⁽¹⁾	16	12,5	14

(Werte in mm, Ausnahme ¹⁾ = Zoll)

Serie »MI und MSI«

11.DM.08010–11.DM.40600, 11.EM.08010–11.EM.40150

Maße »MSI«, einfachwirkend

Ø 8–25

Ø 32–40

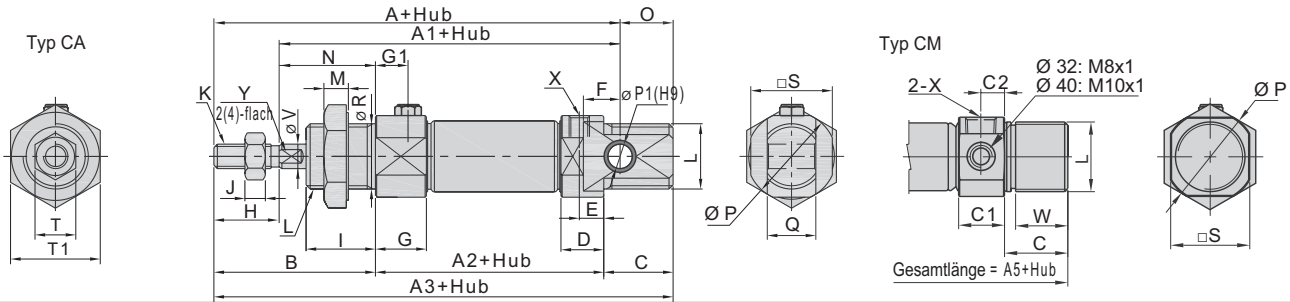

Auf Anfrage:

Typ R

Typ U

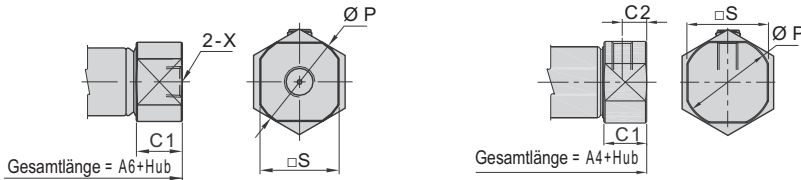

Hub	A			A1			A2			A3		
	0–50	51–100	101–150	0–50	51–100	101–150	0–50	51–100	101–150	0–50	51–100	101–150
Kolben-Ø												
8	101	-	-	89	-	-	71	-	-	111	-	-
10	101	-	-	89	-	-	71	-	-	111	-	-
12	116	-	-	100	-	-	75	-	-	130	-	-
16	123	148	-	107	132	-	81	106	-	136	161	-
20	140	165	190	120	145	170	87	112	137	151	176	201
25	151	176	201	129	154	179	90	115	140	162	187	212
32	-	-	-	-	-	-	-	-	-	-	-	-
40	-	-	-	-	-	-	-	-	-	-	-	-

(Werte in mm)

Hub	A4			A5			A6		
	0–50	51–100	101–150	0–50	51–100	101–150	0–50	51–100	101–150
Kolben-Ø									
8	99	-	-	-	-	-	-	-	-
10	99	-	-	-	-	-	-	-	-
12	113	-	-	-	-	-	-	-	-
16	119	144	-	136	161	-	119	144	-
20	131	156	181	151	176	201	131	156	181
25	139,5	164,5	189,5	162	187	212	140	165	190
32	150	175	200	165	190	215	151	176	201
40	183	208	233	199	224	249	183	208	233

(Werte in mm)

Serie »MI und MSI«

11.DM.08010–11.DM.40600, 11.EM.08010–11.EM.40150

Maße »MSI«, einfachwirkend (Forts.)

Kolben-Ø	B	C	C1	C2	D	E	F	G	G1	H	I	J	K
8	28	12	9,5	5	9,5	5	6	11,5	7	12	12	2,5	M4x0,7
10	28	12	9,5	5	9,5	5	6	11,5	7	12	12	2,5	M4x0,7
12	38	17	10,5	6	10,5	6	9	12,5	8	16	17	5	M6x1,0
16	38	17	10,5	6	10,5	6	9	12,5	8	16	17	5	M6x1,0
20	44	20	14,5	7,5	14,5	7,5	12	14,5	7,5	20	20	6	M8x1,25
25	50	22	16	8	16	8	12	16	8	22	22	6	M10x1,25
32	58	14	16,5	9	-	-	-	16,5	9	20	30	6	M10x1,25
40	69	16	22	12	-	-	-	22	12	24	35	7	M12x1,25

(Werte in mm)

Kolben-Ø	L	M	N	O	P	P1	Q	R	S	T	T1	X	V	W	Y
8	M12x1,25	6	16	10	17	4	8	12	15	7	17	M5x0,8	4	-	-
10	M12x1,25	6	16	10	17	4	8	12	15	7	17	M5x0,8	4	-	-
12	M16x1,5	6	22	14	20	6	12	16	18	10	22	M5x0,8	6	-	5
16	M16x1,5	6	22	13	22	6	12	16	20	10	22	M5x0,8	6	13,5	5
20	M22x1,5	7	24	11	29	8	16	22	25	12	29	1/8" ¹⁾	8	16,5	6
25	M22x1,5	7	28	11	33,5	8	16	22	30	17	29	1/8" ¹⁾	10	18,5	8
32	M30x1,5	7	38	-	37,5	-	-	30	34,5	17	36	1/8" ¹⁾	12	10,5	10
40	M38x1,5	8	45	-	46,5	-	-	38	42,5	17	46	1/4" ¹⁾	16	12,5	14

 (Werte in mm, Ausnahme ¹⁾ = Zoll)

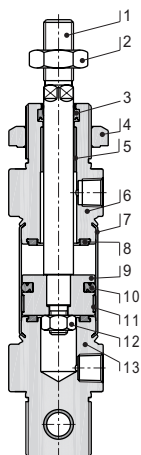
Komponenten und Material

Nr.	Bauteil	Material	
1	Kolbenstange	Edelstahl	
2	Kolbenstangenmutter	Stahl	
3	Kolbenstangendichtung	NBR	
4	Kopfmutter	Stahl	
5	Führungsbuchse	Ø 8–25	-
		Ø 32–40	Verschleißfestes Material (Bronzelegierung)
6	Zylinderdeckel / Kopfseite	Aluminiumlegierung	
7	Gehäuse	Edelstahl	
8	Dämpfungsring	TPU	
9	Kolben	Ø 8–12	Edelstahl
		Ø 16–40	Aluminiumlegierung
10	Kolben O-Ring	NBR	
11	Verschleißring	Verschleißfestes Material	
12	Mutter	Stahl	
13	Zylinderdeckel / Fußseite	Aluminiumlegierung	

Zubehör

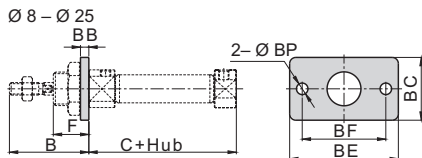
Flanschbefestigung, Typ »FA«
437.240–437.242

Maße und Material

Artikel Nr.	Kolben-Ø	B	C	BB	BC	BE	BF	BP	F	Material
437.240	8	28	46	3	22	40	30	4,5	12	Stahl
	10	28	46	3	22	40	30	4,5	12	
437.241	12	38	50	4	30	52	40	5,5	17	
	16	38	56	4	30	52	40	5,5	17	
437.242	20	44	62	5	40	66	50	6,6	20	
	25	50	65	5	40	66	50	6,6	22	

(Werte in mm)

Für Kolben-Ø 32–40 nicht verfügbar.

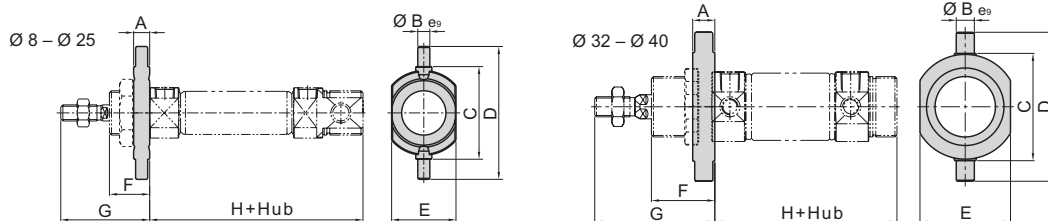
Schwenkkopfbefestigung, Typ »TC«
437.230–437.234

Maße und Material

Artikel Nr.	Kolben-Ø	A	B	C	D	E	F	G	H	Material
437.230	8	6	4	26	38	20	12	28	58	Edelstahl
	10	6	4	26	38	20	12	28	58	
437.231	12	8	6	38	58	25	17	38	67	
	16	8	6	38	58	25	17	38	73	
437.232	20	8	6	46	66	32	20	44	82	
	25	8	6	46	66	32	22	50	87	
437.233	32	11	9	54	74	45	30	58	82	
437.234	40	12	10	64	84	55	35	69	101	

(Werte in mm)

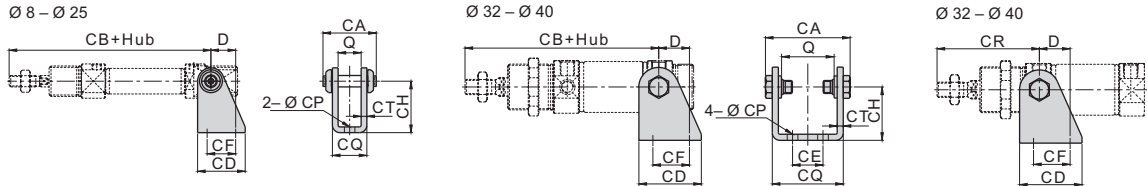
Zubehör
**Schwenklager, Typ »SDB«
 437.250–437.254**

Maße und Material

Artikel Nr.	Kolben-Ø	D	Q	CA	CB	CD	CE	CF	CH	CP	CQ	CT	CR	Material
437.250	8	11	8,1	18,4	76	20	-	12,5	24	4,5	13,1	2,5	-	Stahl
	10	11	8,1	18,4	76	20	-	12,5	24	4,5	13,1	2,5	-	
437.251	12	13	12,1	28	91	25	-	15	27	5,5	18,1	3	-	
	16	13	12,1	28	98	25	-	15	27	5,5	18,1	3	-	
437.252	20	16	16,1	38	115	32	-	20	30	6,6	24,1	4	-	
	25	16	16,1	38	126	32	-	20	30	6,6	24,1	4	-	
437.253	32	20	34,6	55,6	117	41	20	24	35	7	46,6	4	67	
437.254	40	27	42,6	69,6	146	52	28	30	40	9	58,6	5	81	

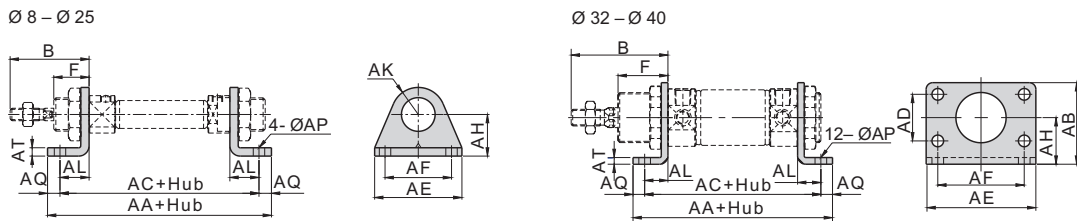
(Werte in mm)

**Fußbefestigung, Typ »LB«
 437.200–437.204**

Maße und Material

Artikel Nr.	Kolben-Ø	B	F	AA	AB	AC	AD	AE	AF	AH	AK	AL	AP	AQ	AT	Material
437.200	8	28	12	78	-	68	-	35	25	16	10	11	4,5	5	3	Stahl
	10	28	12	78	-	68	-	35	25	16	10	11	4,5	5	3	
437.201	12	38	17	90	-	78	-	42	32	20	13	14	5,5	6	4	
	16	38	17	96	-	84	-	42	32	20	13	14	5,5	6	4	
437.202	20	44	20	112	-	96	-	54	40	25	20	17	6,6	8	5	
	25	50	22	115	-	99	-	54	40	25	20	17	6,6	8	5	
437.203	32	58	30	110	49	96	28	66	52	28	-	14	7	7	4	
437.204	40	69	35	149	58	129	30	80	60	33	-	20	9	10	5	

(Werte in mm)

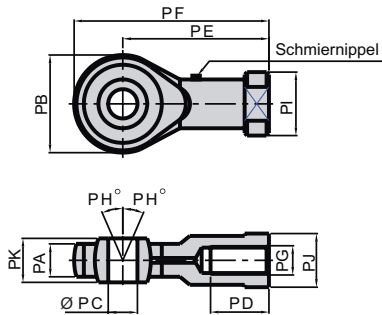
Zubehör

Gelenkauge, Typ »UNIT«
437.320–437.221

Maße und Material

Artikel Nr.	Kolben-Ø	PA	PB	PC(H9)	PD	PE	PF	PG	PH	PI	PJ	PK	Material
437.320	8–10	6	18	4	10	27	36	M4x0,7	13	12,5	10	8	Stahl
437.321	12–16	6,8	20	6	12	30	40	M6x1,0	13	13	11	9	
437.322	20	9	24	8	16	36	48	M8x1,25	13	16	14	12	
437.220	25–32	11	26	10	20	43	56	M10x1,25	13	19	17	14	
437.221	40	12	32	12	22	50	66	M12x1,25	13	22	19	16	

(Werte in mm)

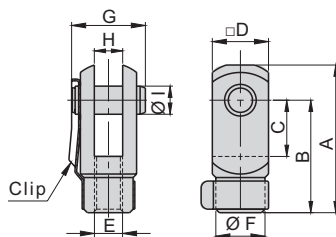
Gabelkopf, Typ »Y«
437.310–437.313, 437.211

Maße und Material

Artikel Nr.	Kolben-Ø	A	B	C	D	E	F	G	H	I	Material
437.310	8–10	22	16	8	8	M4x0,7	7	11,5	4	4	Stahl
437.311	12–16	32	24	12	12	M6x1,0	10	16	6	6	
437.312	20	42	32	16	16	M8x1,25	14	21	8	8	
437.313	25-32	52	40	20	19	M10x1,25	18	25	10	10	
437.211	40	62	48	24	25,4	M12x1,25	26,2	32,4	12	12	

(Werte in mm)

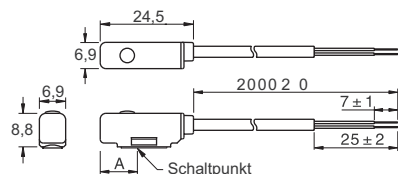
Zubehör
**Sensorschalter, Typ »CS1«
 235.300–235.357**

	REED, NO	HALL, NO, NPN, PNP
A	9,5	4

(Werte in mm)

Technische Daten

	REED, NO	HALL, NO, NPN	HALL, NO, PNP
Schaltprinzip	STSP In Ruhestellung geöffnet	Transistor kontaktlos, in Ruhestellung geöffnet	
Sensor Typ	REED-Kontaktschalter	Typ NPN	Typ PNP
Betriebsspannung	5–240 V AC/DC	5–30 V DC	
Max. Schaltstrom	100 mA	200 mA	
Schaltspannung	Max. 10 W	Max. 6 W	
Stromaufnahme	NO	15 mA max. bei 24 V	
Spannungsabfall	2,5 V max. bei 100 mA DC	0,5 V max. bei 200 mA DC	
Kabel	Ø 3,3, 2C, grau, ölbeständig PVC (schwer entflammbar)	Ø 3,3, 3C, schwarz, ölbeständig PVC (schwer entflammbar)	
Kontrollanzeige	LED rot	LED rot	
Verluststrom	NO	0,01 mA max.	
Empfindlichkeit	Kolben-Ø 8–10	45–55 Gauss	45–55 Gauss
	Kolben-Ø 12–16	55–65 Gauss	55–65 Gauss
	Kolben-Ø 20–40	65–70 Gauss	65–70 Gauss
Max. Frequenz	200 Hz	1000 Hz	
Stoßbelastung	300 m/s ²	500 m/s ²	
Vibration	90 m/s ²	90 m/s ²	
Temperaturbereich	-10 bis 70 °C	-10 bis 70 °C	
Schutzart	IP67 (NEMA6)	IP67 (NEMA6)	
Schutzschaltung	NO	Verpolungssicher, Überspannungsschutz	

Bestellinformationen

Artikel Nr.	Typ
235.300–235.307	REED-Sensor, 2-Draht, M8-Stecker, 150 mm Kabel, NO
235.310–235.317	REED-Sensor, 2-Draht, 3 m Kabel, NO
235.320–235.327	HALL-Sensor, 3-Draht, M8-Stecker, 150 mm Kabel, NO, NPN
235.330–235.337	HALL-Sensor, 3-Draht, 3 m Kabel, NO, NPN
235.340–235.347	HALL-Sensor, 3-Draht, M8-Stecker, 150 mm Kabel, NO, PNP
235.350–235.357	HALL-Sensor, 3-Draht, 3 m Kabel, NO, PNP

Zubehör

Montage

Zur Montage des Sensors bitte die folgenden Schritte beachten:

1. Legen Sie das Stahlband um das Zylindergehäuse.
2. Bringen Sie die Befestigungsschraube in die dafür vorgesehene Öffnung und schieben diese in die gewünschte Position.
3. Befestigungsschraube festdrehen.

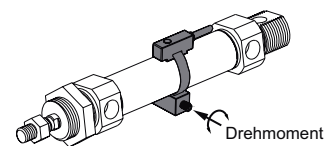
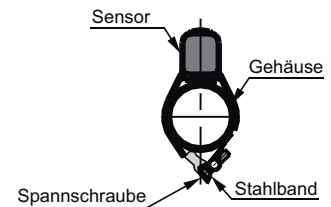

Bestellinformationen

Artikel Nr.	Ident Nr.
11.DM.08010	114771
11.DM.08015	114772
11.DM.08020	114773
11.DM.08025	114774
11.DM.08030	114775
11.DM.08040	114776
11.DM.08050	114777
11.DM.08060	114778
11.DM.08075	114779
11.DM.08080	114780
11.DM.08100	114781
11.DM.08125	114782
11.DM.08150	114783
11.DM.10010	114784
11.DM.10015	114785
11.DM.10020	114786
11.DM.10025	114787
11.DM.10030	114788
11.DM.10040	114789
11.DM.10050	114790
11.DM.10060	114791
11.DM.10075	114792
11.DM.10080	114793
11.DM.10100	114794
11.DM.10125	114795
11.DM.10150	114796
11.DM.10160	114797
11.DM.10175	114798
11.DM.10200	114799
11.DM.12010	114800
11.DM.12015	114801
11.DM.12020	114802
11.DM.12025	114803
11.DM.12030	114804
11.DM.12040	114805
11.DM.12050	114806
11.DM.12060	114807
11.DM.12075	114808
11.DM.12080	114809
11.DM.12100	114810
11.DM.12125	114811
11.DM.12150	114812
11.DM.12160	114813
11.DM.12175	114814
11.DM.12200	114815
11.DM.12250	114816
11.DM.16010	114817
11.DM.16015	114818
11.DM.16020	114819
11.DM.16025	114820
11.DM.16030	114821
11.DM.16040	114822
11.DM.16050	114823
11.DM.16060	114824
11.DM.16075	114825

Bestellinformationen

Artikel Nr.	Ident Nr.
11.DM.16080	114826
11.DM.16100	114827
11.DM.16125	114828
11.DM.16150	114829
11.DM.16160	114830
11.DM.16175	114831
11.DM.16200	114832
11.DM.16250	114833
11.DM.16300	114834
11.DM.20010	114835
11.DM.20015	114836
11.DM.20020	114837
11.DM.20025	114838
11.DM.20030	114839
11.DM.20040	114840
11.DM.20050	114841
11.DM.20060	114842
11.DM.20075	114843
11.DM.20080	114844
11.DM.20100	114845
11.DM.20125	114846
11.DM.20150	114847
11.DM.20160	114848
11.DM.20175	114849
11.DM.20200	114850
11.DM.20250	114851
11.DM.20300	114852
11.DM.20350	114853
11.DM.20400	114854
11.DM.20450	114855
11.DM.20500	114856
11.DM.20600	114857
11.DM.25010	114858
11.DM.25015	114859
11.DM.25020	114860
11.DM.25025	114861
11.DM.25030	114862
11.DM.25040	114863
11.DM.25050	114864
11.DM.25060	114865
11.DM.25075	114866
11.DM.25080	114867
11.DM.25100	114868
11.DM.25125	114869
11.DM.25150	114870
11.DM.25160	114871
11.DM.25175	114872
11.DM.25200	114873
11.DM.25250	114874
11.DM.25300	114875
11.DM.25350	114876
11.DM.25400	114877
11.DM.25450	114878
11.DM.25500	114879
11.DM.25600	114880

Bestellinformationen

Artikel Nr.	Ident Nr.
11.DM.32010	114881
11.DM.32015	114882
11.DM.32020	114883
11.DM.32025	114884
11.DM.32030	114885
11.DM.32040	114886
11.DM.32050	114887
11.DM.32060	114888
11.DM.32075	114889
11.DM.32080	114890
11.DM.32100	114891
11.DM.32125	114892
11.DM.32150	114893
11.DM.32160	114894
11.DM.32175	114895
11.DM.32200	114896
11.DM.32250	114897
11.DM.32300	114898
11.DM.32350	114899
11.DM.32400	114900
11.DM.32450	114901
11.DM.32500	114902
11.DM.32600	114903
11.DM.40010	114904
11.DM.40015	114905
11.DM.40020	114906
11.DM.40025	114907
11.DM.40030	114908
11.DM.40040	114909
11.DM.40050	114910
11.DM.40060	114911
11.DM.40075	114912
11.DM.40080	114913
11.DM.40100	114914
11.DM.40125	114915
11.DM.40150	114916
11.DM.40160	114917
11.DM.40175	114918
11.DM.40200	114919
11.DM.40250	114920
11.DM.40300	114921
11.DM.40350	114922
11.DM.40400	114923
11.DM.40450	114924
11.DM.40500	114925
11.DM.40600	114926
11.EM.08010	114927
11.EM.08015	114928
11.EM.08020	114929
11.EM.08025	114930
11.EM.08030	114931
11.EM.08040	114932
11.EM.08050	114933
11.EM.10010	114934
11.EM.10015	114935

Bestellinformationen

Artikel Nr.	Ident Nr.
11.EM.10020	114936
11.EM.10025	114937
11.EM.10030	114938
11.EM.10040	114939
11.EM.10050	114940
11.EM.12010	114941
11.EM.12015	114942
11.EM.12020	114943
11.EM.12025	114944
11.EM.12030	114945
11.EM.12040	114946
11.EM.12050	114947
11.EM.16010	114948
11.EM.16015	114949
11.EM.16020	114950
11.EM.16025	114951
11.EM.16030	114952
11.EM.16040	114953
11.EM.16050	114954
11.EM.16060	114955
11.EM.16075	114956
11.EM.16080	114957
11.EM.16100	114958
11.EM.20010	114959
11.EM.20015	114960
11.EM.20020	114961
11.EM.20025	114962
11.EM.20030	114963
11.EM.20040	114964
11.EM.20050	114965
11.EM.20060	114966
11.EM.20075	114967
11.EM.20080	114968
11.EM.20100	114969
11.EM.20125	114970
11.EM.20150	114971
11.EM.25010	114972
11.EM.25015	114973
11.EM.25020	114974
11.EM.25025	114975
11.EM.25030	114976
11.EM.25040	114977
11.EM.25050	114978
11.EM.25060	114979
11.EM.25075	114980
11.EM.25080	114981
11.EM.25100	114982
11.EM.25125	114983
11.EM.25150	114984

Bestellinformationen

Artikel Nr.	Ident Nr.
11.EM.32010	114985
11.EM.32015	114986
11.EM.32020	114987
11.EM.32025	114988
11.EM.32030	114989
11.EM.32040	114990
11.EM.32050	114991
11.EM.32060	114992
11.EM.32075	114993
11.EM.32080	114994
11.EM.32100	114995
11.EM.32125	114996
11.EM.32150	114997
11.EM.40010	114998
11.EM.40015	114999
11.EM.40020	115000
11.EM.40025	115001
11.EM.40030	115002
11.EM.40040	115003
11.EM.40050	115004
11.EM.40060	115005
11.EM.40075	115006
11.EM.40080	115007
11.EM.40100	115008
11.EM.40125	115009
11.EM.40150	115010

Bestellinformationen

Artikel Nr.	Ident Nr.
437.200	115804
437.201	115805
437.202	115806
437.203	115807
437.204	115808
437.240	115824
437.241	115825
437.242	115826
437.250	115827
437.251	115828
437.252	115829
437.253	115830
437.254	115831
437.230	115819
437.231	115820
437.232	115821
437.233	115822
437.234	115823
437.310	115832
437.311	115833
437.312	115834
437.313	115835
437.211	115810
437.320	115836
437.321	115837
437.322	115838
437.220	115814
437.221	115815
235.300	115539
235.301	115540
235.302	115541
235.303	115542
235.304	115543
235.305	115544
235.306	115545
235.307	115546
235.310	115547
235.311	115548
235.312	115549
235.313	115550
235.314	115551
235.315	115552
235.316	115553
235.317	115554
235.320	115555
235.321	115556
235.322	115557
235.323	115558
235.324	115559
235.325	115560
235.326	115561
235.327	115562

Bestellinformationen

Artikel Nr.	Ident Nr.
235.330	115563
235.331	115564
235.332	115565
235.333	115566
235.334	115567
235.335	115568
235.336	115569
235.337	115570
235.340	115571
235.341	115572
235.342	115573
235.343	115574
235.344	115575
235.345	115576
235.346	115577
235.347	115578
235.350	115579
235.351	115580
235.352	115581
235.353	115582
235.354	115583
235.355	115584
235.356	115585
235.357	115586