



3/2-5/2-5/3 Wege elektropneumatisch

Baureihe 517
 Ident Nr. 106520 bis 106591

G 1/8	G 1/4	G 3/8	G 1/2
NW 5	NW 7,5	NW 13,3	NW 15

Ventile Reihe 517

Traditionelle Wegeventil-Baureihe. Der Einsatzbereich erstreckt sich auf **alle** Anwendungen zur Betätigung **pneumatischer** Aktoren. Diese Ventile sind als Muffenventile, zum Direktanbau an Zylinder (mit Spezialadapter) oder als Serienventile mit Mehrfachgrundplatte und Einzelverkettungsplatte ausgeführt.

Verfügbar sind:

- vier Anschlussgrößen (1/8", 1/4", 3/8" und 1/2")
- vier Betätigungsarten (manuell, mechanisch, pneumatisch und elektropneumatisch)
- Wege-Versionen 3/2, 5/2 und 5/3

Technische Daten

Benennung	G 1/8	G 1/4	G 3/8	G 1/2
Arbeitsdruckbereich max.	10 bar			
Minimaler Arbeitsdruck	2,5 bar 1,0 bar			
- monostabil				
- bistabil				
Temperaturbereich	-10 ... +60 °C			
Nenn Durchmesser (mm)	5	7,5	13,3	15
Durchfluss [NI/min – bar]	121,43	264,26	505,52	971,43
Kritischer Faktor b	0,32 bar/bar	0,27 bar/bar	0,32 bar/bar	0,43 bar/bar
Durchfluss / 6 bar - Δ0,5 bar	400 NI/min	750 NI/min	1560 NI/min	3200 NI/min
Durchfluss / 6 bar - Δ1,0 bar	550 NI/min	1100 NI/min	2150 NI/min	4600 NI/min
TRA/TRR monostabil bei 6 bar*	15 ms / 35 ms	19 ms / 45 ms	21 ms / 72 ms	36 ms / 60 ms
TRA/TRR bistabil bei 6 bar*	20 ms / 20 ms	21 ms / 21 ms	18 ms / 18 ms	30 ms / 30 ms
Handhilfsbetätigung	bistabil			
elektrische Spannung	24 V/DC – 24 V/AC – 110 V/AC – 230 V/AC 50/60Hz			
elektrische Leistung	2 W (DC) 3,5 VA (AC)			
Isolationsklasse	F (max. Eigenerwärmung der Magnetspule 155 °C)			

* TRA /TRR →Ein/Ausschaltzeit bei einem Druckaufbau von 95% bezogen auf 6 bar

Werkstoffe

①	Ventilkörper	Aluminium (oberflächenvergütet)
②	Endstücke	Hostaform®
③	Kolben	Aluminium (chemisch vernickelt)
④	Distanzstück	Kunststoff
⑤	Dichtungen	NBR
⑥	Hilfskolben	Hostaform®
⑦	Dichtung	NBR
⑧	Filter	Gesinterte Bronze
⑨	Feder	Sonderstahl
↪	Ankersystem	Messinghülse / Anker-Edelstahl

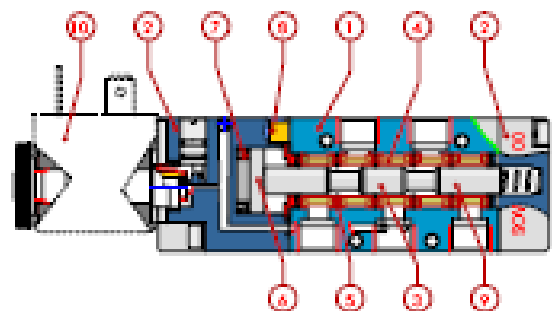



Geräteauswahl

Artikel Nr.	Ident Nr.	Anschluss	U	NW	Funktion		Rückstellung	Schaltbild		
					Wege	Grundstellung				
517.101	106520	G 1/8	24 V DC	5	3/2	Monostabil NO	Mechanische Feder			
517.102	106521	G 1/4		7,5						
517.102-38	106522	G 3/8		13,3						
517.103	106523	G 1/2		15						
517.104	106524	G 1/8	230/50	5		Monostabil NO				
517.105	106525	G 1/4		7,5						
517.105-38	106526	G 3/8		13,3						
517.106	106527	G 1/2		15						
517.111	106528	G 1/8	24V DC	5		3/2		Monostabil NC	Mechanische Feder	
517.112	106529	G 1/4		7,5						
517.112-38	106530	G 3/8		13,3						
517.113	106531	G 1/2		15						
517.114	106532	G 1/8	230/50	5				Monostabil NC		
517.115	106533	G 1/4		7,5						
517.115-38	106534	G 3/8		13,3						
517.116	106535	G 1/2		15						
517.121	106536	G 1/8	24 V DC	5	3/2		Bistabil			
517.122	106537	G 1/4		7,5						
517.122-38	106538	G 3/8		13,3						
517.123	106539	G 1/2		15						
517.124	106540	G 1/8	230/50	5			Bistabil			
517.125	106541	G 1/4		7,5						
517.125-38	106542	G 3/8		13,3						
517.126	106543	G 1/2		15						

Zubehör

Grundplatten	Versorgungsleisten	Anschlusstecker	Magnete
⇒ siehe	⇒ siehe	⇒ siehe	⇒ siehe
Blatt 15-G-1	Blatt 15-V-1	Blatt 15-Z-1	Blatt 15-Z-1

Geräteauswahl

Artikel Nr.	Ident Nr.	Anschluss	U	NW	Funktion		Rückstellung	Schaltbild
					Wege	Grundstellung		
517.201	106544	G 1/8	24 V DC	5	5/2	Monostabil	Mechanische Feder	
517.202	106545	G 1/4		7,5				
517.202-38	106546	G 3/8		13,3				
517.203	106547	G 1/2		15				
517.204	106548	G 1/8	230/50	5				
517.205	106549	G 1/4		7,5				
517.205-38	106550	G 3/8		13,3				
517.206	106551	G 1/2		15				
517.211	106552	G 1/8	24V DC	5		5/2	Bistabil	
517.212	106553	G 1/4		7,5				
517.212-38	106554	G 3/8		13,3				
517.213	106555	G 1/2		15				
517.214	106556	G 1/8	230/50	5				
517.215	106557	G 1/4		7,5				
517.215-38	106558	G 3/8		13,3				
517.216	106559	G 1/2		15				
517.221	106560	G 1/8	24 V DC	5	5/2		Differenzialkolben Bistabil	
517.222	106561	G 1/4		7,5				
517.222-38	106562	G 3/8		13,3				
517.223	106563	G 1/2		15				
517.224	106564	G 1/8	230/50	5				
517.225	106565	G 1/4		7,5				
517.225-38	106566	G 3/8		13,3				
517.226	106567	G 1/2		15				

Zubehör

Grundplatten	Versorgungsleisten	Anschlussstecker	Magnete
⇒siehe	⇒siehe	⇒siehe	⇒siehe
Blatt 15-G-1	Blatt 15-V-1	Blatt 15-Z-1	Blatt 15-Z-1

Geräteauswahl

Artikel Nr.	Ident Nr.	Anschluss	U	NW	Funktion		Schaltbild	
					Wege	Grundstellung		
517.301	106568	G 1/8	24 V DC	5	5/3	Mittelstellung geschlossen		
517.302	106569	G 1/4		7,5				
517.302-38	106570	G 3/8		13,3				
517.303	106571	G 1/2		15				
517.304	106572	G 1/8	230/50	5				
517.305	106573	G 1/4		7,5				
517.305-38	106574	G 3/8		13,3				
517.306	106575	G 1/2		15				
517.311	106576	G 1/8	24V DC	5		5/3	Mittelstellung entlüftet	
517.312	106577	G 1/4		7,5				
517.312-38	106578	G 3/8		13,3				
517.313	106579	G 1/2		15				
517.314	106580	G 1/8	230/50	5				
517.315	106581	G 1/4		7,5				
517.315-38	106582	G 3/8		13,3				
517.316	106583	G 1/2		15				
517.321	106584	G 1/8	24 V DC	5	5/3		Mittelstellung belüftet	
517.322	106585	G 1/4		7,5				
517.322-38	106586	G 3/8		13,3				
517.323	106587	G 1/2		15				
517.324	106588	G 1/8	230/50	5				
517.325	106589	G 1/4		7,5				
517.325-38	106590	G 3/8		13,3				
517.326	106591	G 1/2		15				

Zubehör

Grundplatten	Versorgungsleisten	Anschlussstecker	Magnete
⇒siehe	⇒siehe	⇒siehe	⇒siehe
Blatt 15-G-1	Blatt 15-V-1	Blatt 15-Z-1	Blatt 15-Z-1

Abmessungen

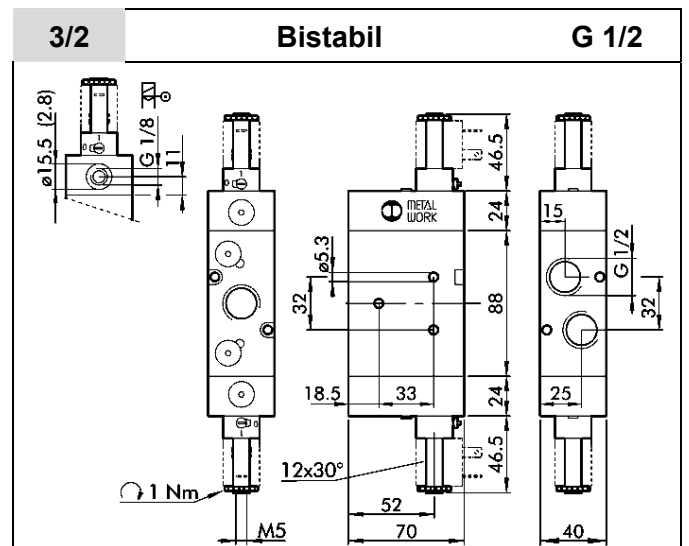
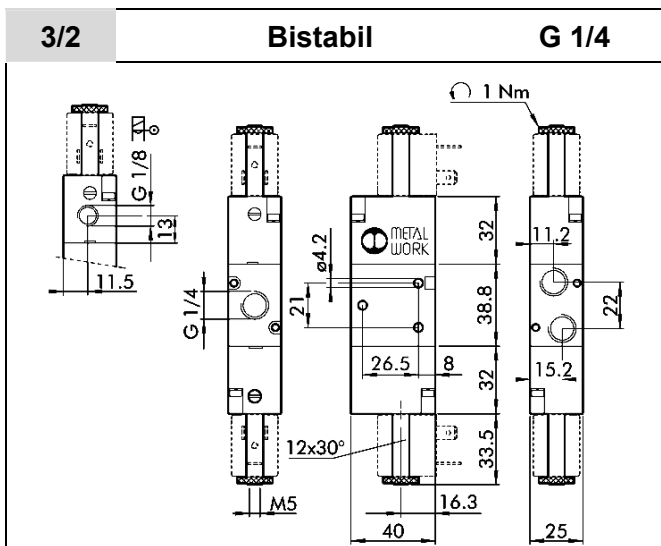
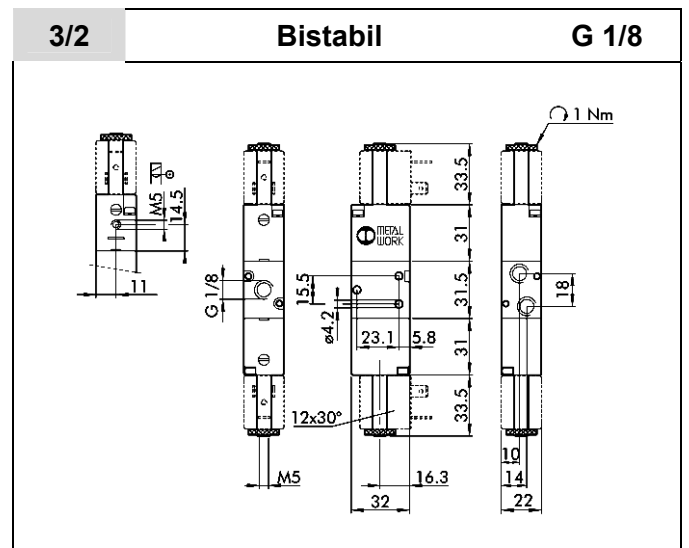
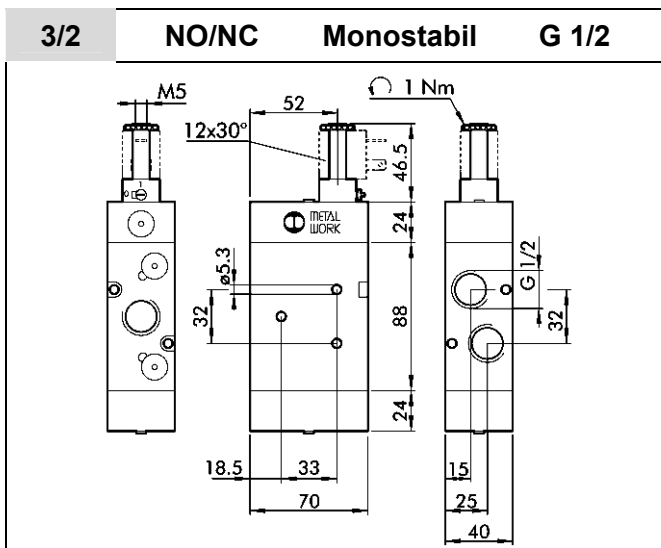
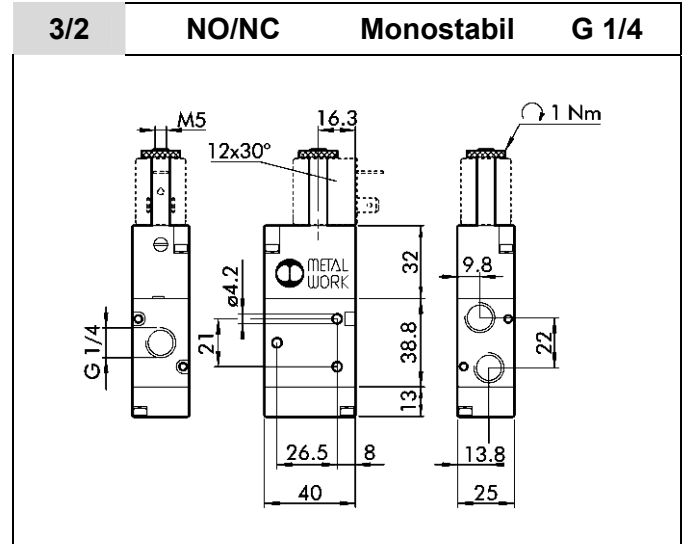
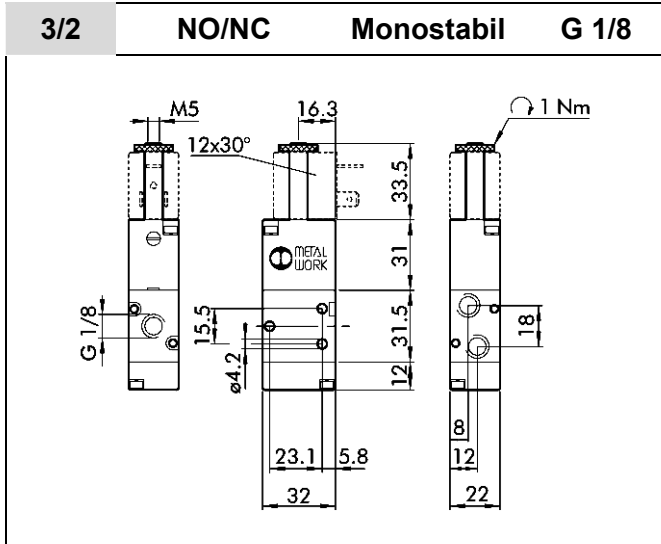

Abmessungen

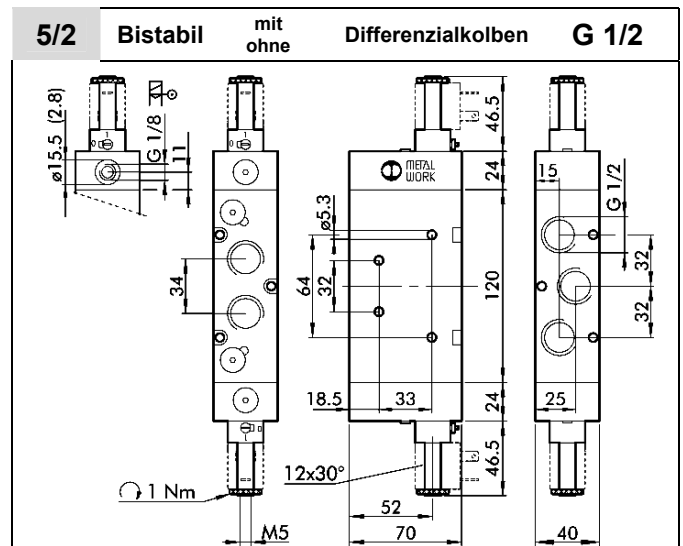
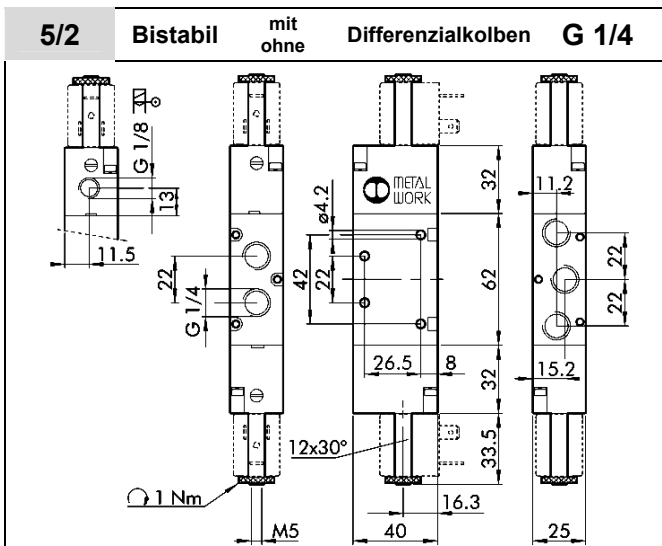
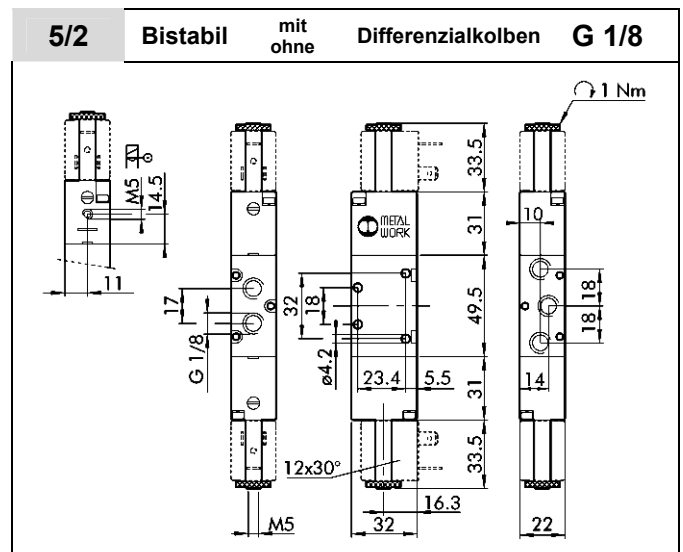
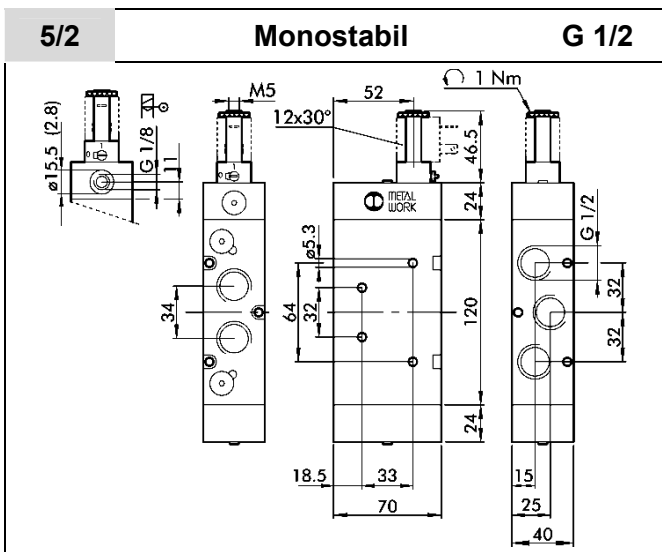
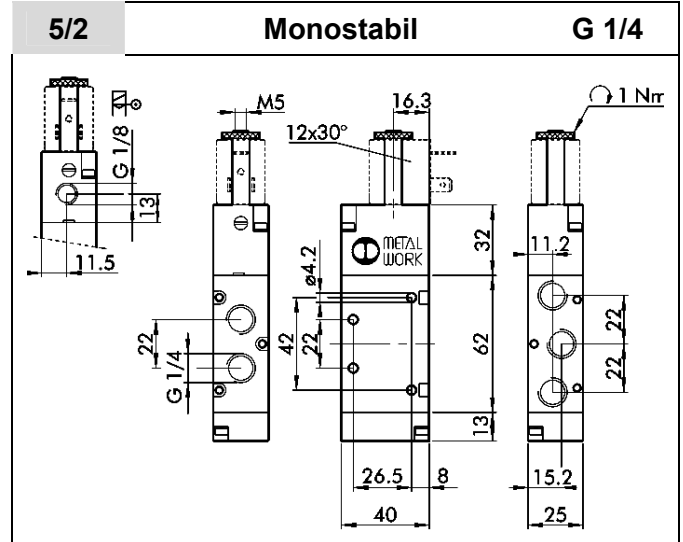
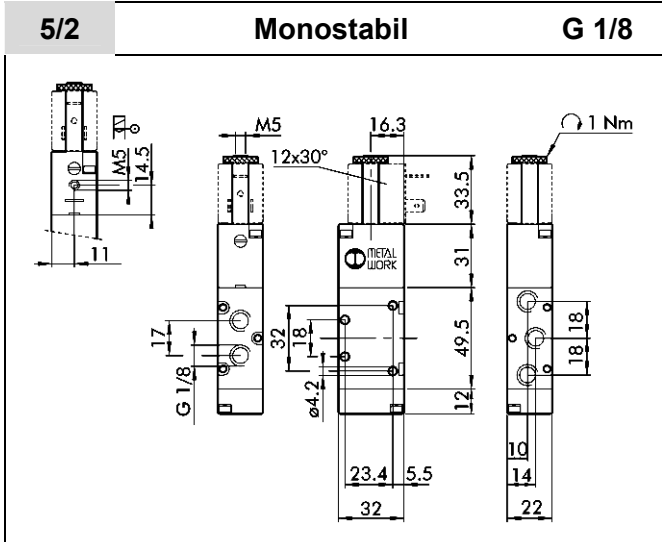

Abmessungen

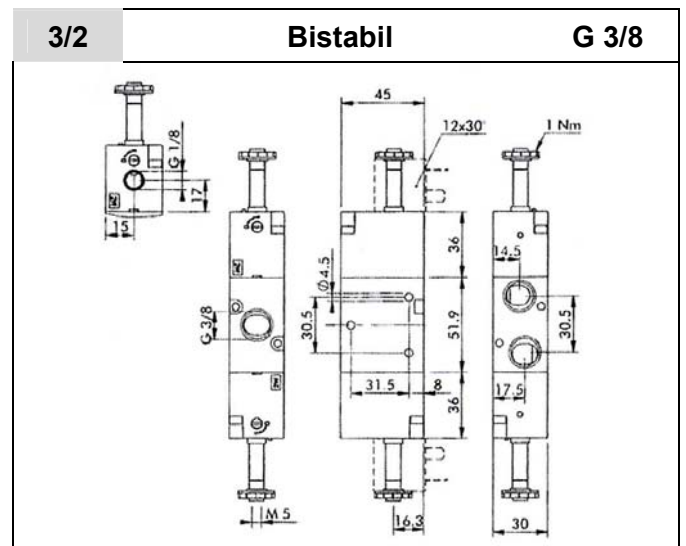
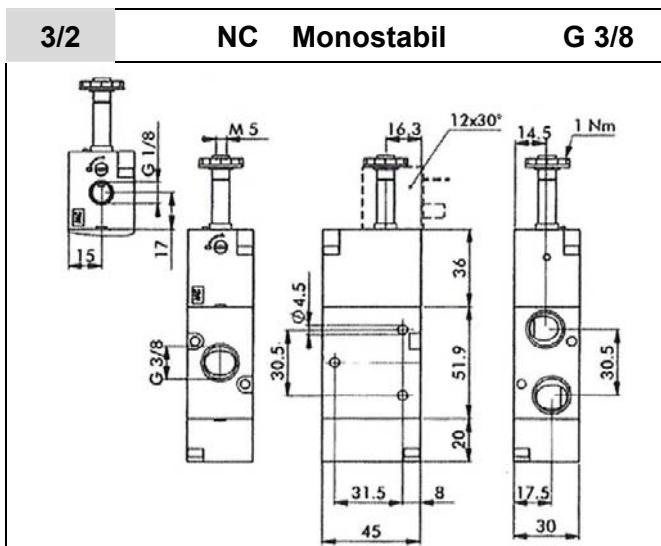
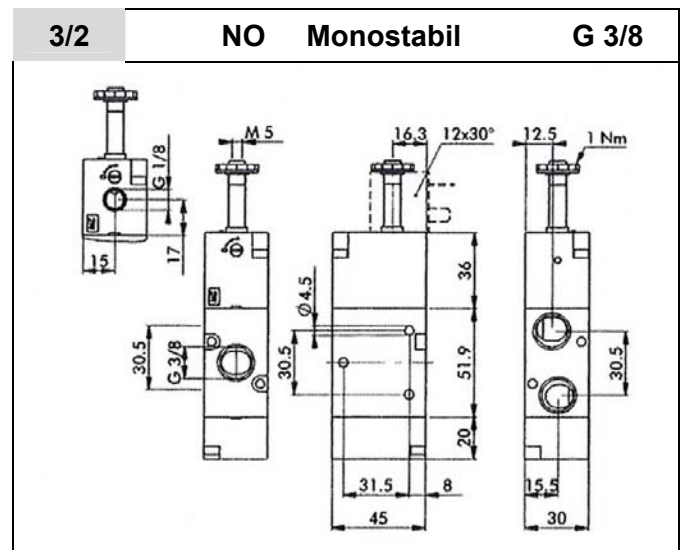
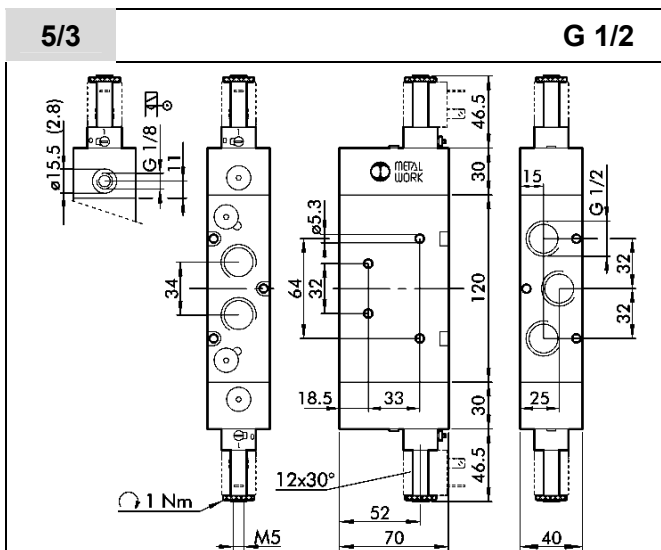
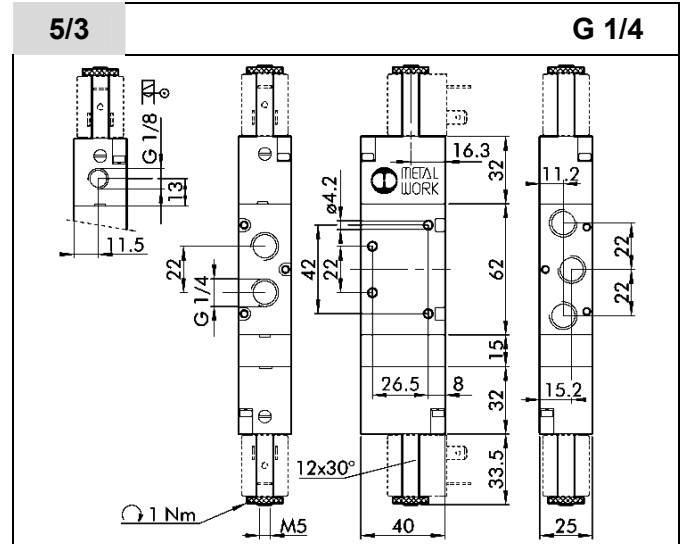
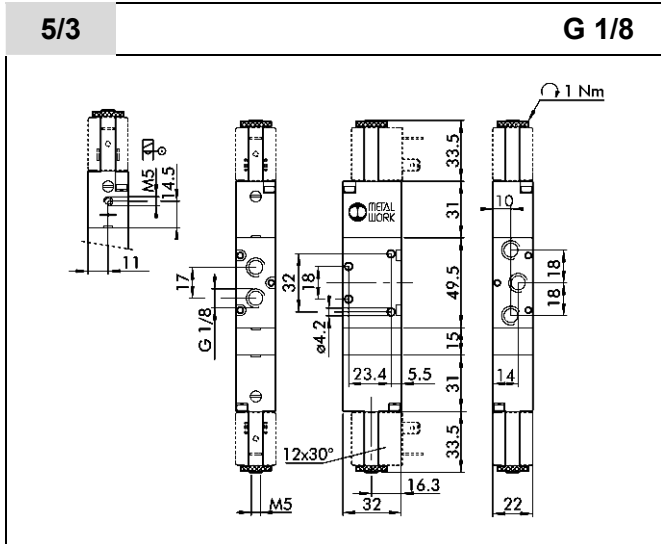

Abmessungen

